

Barra antipánico cierre arriba-abajo.
Anti-panique 2 points haut et bas (coupe-feu)
Barra antipânico fecho duplo (corta-fogo)

Sólo para cerraduras de embutir
Seulement pour les serrures à mortaise
Apenas para fechaduras de embutir

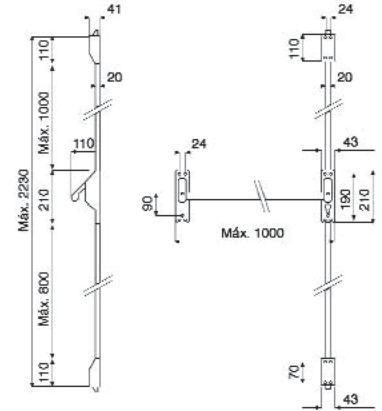

Código code/código	Modelo	
86-492	Arriba-abajo	1

Cerradura antipánico reversible de embutir. Zincada.
Serrure pour anti-panique à mortaise (coupe-feu). Zingué
Fechadura antipânico reversível de embutir. Zincada (corta-fogo)

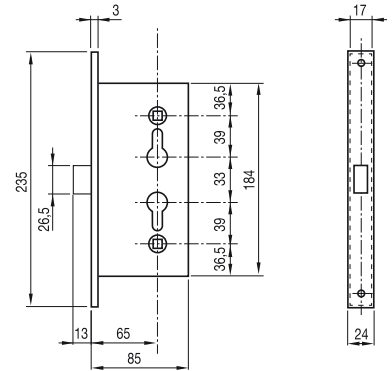

Código code/código	Modelo	
86-496	Cerradura reversible	1

Manilla de sobreponer.
Poignée pour anti-panique superposer
Maçaneta abertura exterior

Sólo para cerraduras de sobreponer
Seulement pour les serrures superposer
Apenas para fechaduras de aparafusar

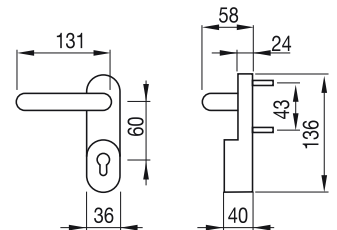

Código code/código	Modelo	
86-500/10	Manilla abertura exterior	1

Pomo de sobreponer.

Poignée pour anti-panique superposer

Maçaneta abertura exterior

Sólo para cerraduras de sobreponer
Seulement pour les serrures superposer
Apenas para fechaduras de aparafusar

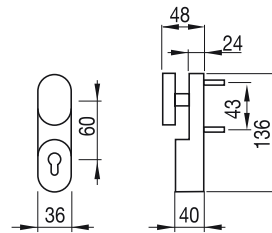

Código code/código	Modelo	
86-500/14	Pomo abertura exterior	1

Antipánico sobreponer 1 punto.

Anti-panique 1 point superposer

Barra antipânico 1 ponto

Sólo para cerraduras de sobreponer
Seulement pour les serrures superposer
Apenas para fechaduras de aparafusar

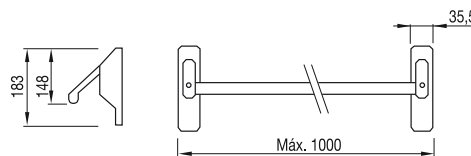

Código code/código	Modelo	
86-500/20	Antipánico sobreponer 1 punto	1

Antipánico sobreponer 2 puntos.

Anti-panique 2 points superposer

Barra antipânico 2 pontos

Sólo para cerraduras de sobreponer
Seulement pour les serrures superposer
Apenas para fechaduras de aparafusar

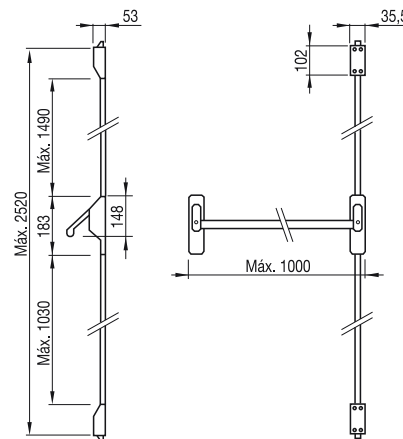

Código code/código	Modelo	
86-500/24	Antipánico sobreponer 2 puntos. 2,4 m.	1
86-500/28	Antipánico sobreponer 2 puntos. 3,2 m.	1