

Gancho elevación con pestillo Acero al carbono C40

Gancho de olhal em carbono C40 com patilha de segurança

Crochets de levage en acier carbone C40 avec linguet



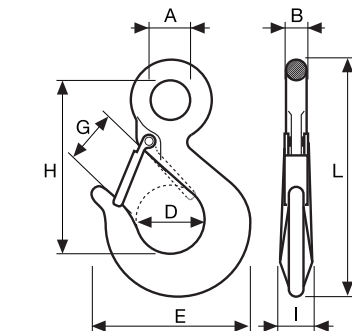

Gancho fijo
Gancho fixo
Crochet fixe



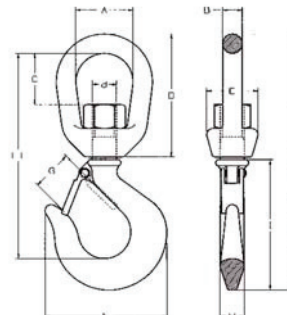

Gancho giratorio
Gancho giratorio
Crochet pivotante



Gancho fijo Gancho fixo Crochet fixe

Código código / code	Referencia referência / référence	A (mm)	B (mm)	C (mm)	E (mm)	G (mm)	H (mm)	I (mm)	L (mm)	 (kg)	 (kg)
79-516	GAN-C-0,8	19	10	30	73	21,5	80	15,0	110	0,260	800
79-518	GAN-C-1,0	23	12	32	82	23,0	93	17,5	125	0,350	1.000
79-520	GAN-C-1,6	27	13	35	93	23,0	103	20,5	142	0,620	1.600
79-522	GAN-C-2,0	30	16	38	105	24,0	117	22,0	165	0,930	2.000
79-524	GAN-C-3,2	38	19	46	125	26,5	145	28,5	240	1,730	3.200
79-526	GAN-C-5,0	50	24	60	168	40,0	182	35,0	255	3,420	5.000

Gancho giratorio Gancho giratorio Crochet pivotante

Código código / code	Referencia referência / référence	A (mm)	B (mm)	C (mm)	D (mm)	E (mm)	F (mm)	G (mm)	H (mm)	I (mm)	L (mm)	 (kg)	 (kg)
79-528	GAN-G-0,8	32	10	34	64	25	73	25	14,0	77	142,0	0,450	800
79-529	GAN-G-1,0	38	13	34	82	34	81	27	16,0	86	170,0	0,770	1.000
79-530	GAN-G-1,6	46	16	42	99	38	92	29	19,0	94	197,5	1,220	1.600
79-531	GAN-G-2,0	50	18	47	110	48	104	32	21,5	106	219,5	1,510	2.000
79-532	GAN-G-3,2	57	20	55	127	54	125	38	28,5	133	262,0	2,480	3.200
79-533	GAN-G-5,0	68	26	59	146	60	166	48	35,0	167	315,0	6,060	5.000

Casquillo Talorit aluminio Casquillo Talorit alumínio Manchon aluminium

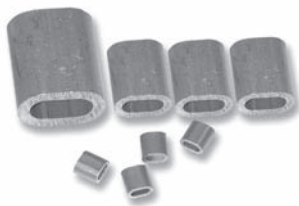

Código código / code	Referencia referência / référence	Ø Cable (mm) Ø cabo / Ø câble
79-538	CST-04	4
79-542	CST-05	5
79-546	CST-06	6
79-550	CST-08	8

Tenazas prensatalorit Alicate Prensatalorit Tenailles à manchonner



Código código / code	Referencia referência / référence
79-602	Tenazas prensatalorit

* Para casquillos de hasta 5 mm

* Para casquillo até 5mm

* Pour manchon jusqu'à 5 mm